

Timers (with adjustable timing)

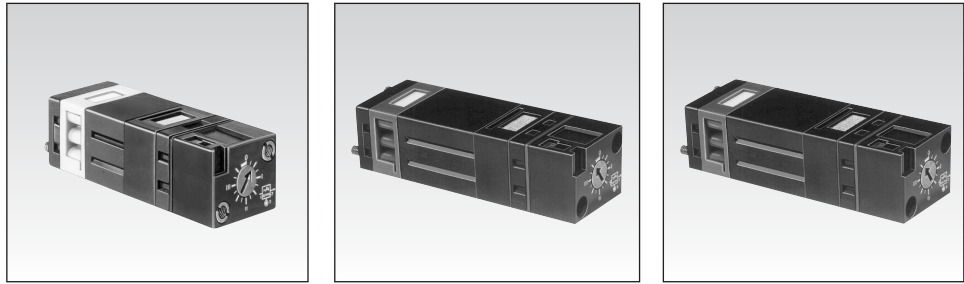

Part numbers

	81 503 710	81 506 710	81 503 720	81 506 720	81 503 725	81 506 725
Function	positive	negative	positive	negative	positive	negative
	●	○	●	○	●	○

Symbol

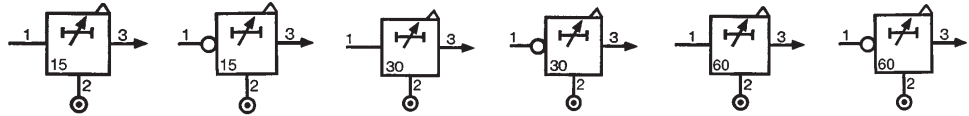

Characteristics

Timing	s	0.1 • 15	0.1 • 15	0.1 • 30	0.1 • 30	0.1 • 60	0.1 • 60
Operating pressure	psi (bar)	30 > 120 (2 > 8)	30 > 120 (2 > 8)	30 > 120 (2 > 8)	30 > 120 (2 > 8)	30 > 120 (2 > 8)	30 > 120 (2 > 8)
Flow at 6 bars	cfm (Nl/min)	6 (170)	6 (170)	6 (170)	6 (170)	6 (170)	6 (170)
Orifice diameter	inches (mm)	0.406 (27)	0.406 (27)	0.406 (27)	0.406 (27)	0.106 (2.7)	0.106 (2.7)
Accuracy	%	± 5	± 5	± 5	± 5	± 5	± 5
Min. reset time	s	<0.1	<0.1	<0.1	<0.1	<0.1	<0.1
Connection - On sub-base page 5/44 - 5/45		●	●	●	●	●	●
Operating temperature	°C	-5 +50	-5 +50	-5 +50	-5 +50	-5 +50	-5 +50
Mechanical life	operations	>10 ⁷	>10 ⁷	>10 ⁷	>10 ⁷	>10 ⁷	>10 ⁷
Weight	g	90	90	100	100	120	120

Accessories

Panel mounting adaptor	79 451 698	79 451 698	79 451 903	79 451 903	—	—
Weight	g	53	53	53	—	—

Principle

The operation of these pneumatic timers is similar to that of electronic timers (circuit with capacitor/resistor)

Principle of operation

with positive output

with negative output

Timing by charging of reservoir

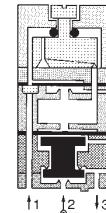
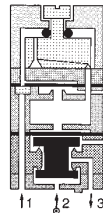
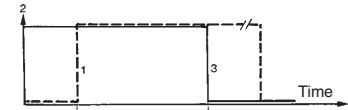
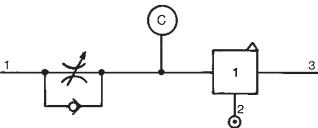

The reservoir fills via the flow restrictor until the switching point of the timer output is reached (positive or negative).
The non-return valve allows the reservoir to be emptied rapidly for the next timing.

Dimensions

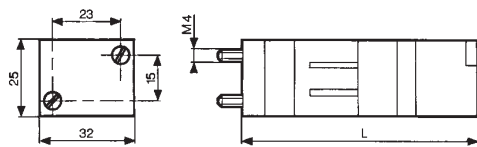

Part numbers	L (mm)
81 503 710 - 81 506 710	78
81 503 720 - 81 506 720	92
81 503 725 - 81 506 725	125

Adaptor 79 451 ...

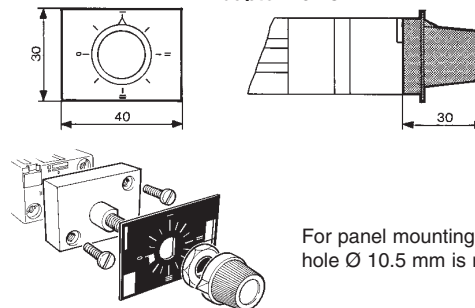

For panel mounting, a pre-drilled hole Ø 10.5 mm is required

To order, specify :

Standard products

1 Part number

2 Accessory

Standard products, non stocked

Example : Timers (with adjustable timing) - 81 503 710 - Adaptor 79 451 698

Products and specifications subject to change without notice.

Order/Technical Support – Tel: (800) 677-5311 / FAX: (800) 677-3865 / www.crouzet-usa.com